

SHOT SHOW

JANUARY 17 - 20, 2017

SANDS EXPO - LEVEL 1 - HALL G & BALLROOMS - LAS VEGAS, NV

REFER TO SHOT SHOW DISPLAY HEIGHT REGULATIONS FOR MAXIMUM BUILD HEIGHT; HANGING SIGNS & MULTI-LEVEL BOOTHS ARE NOT PERMITTED ON THE LEVEL 1

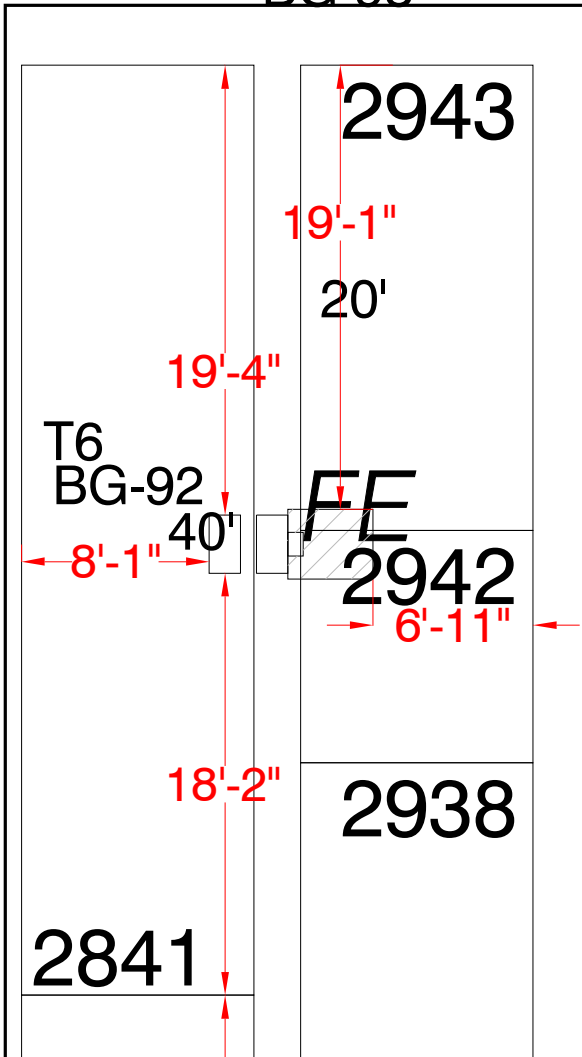

BUILDING LEGEND



Ceiling Restrictions: LEVEL 1

- MAXIMUM BOOTH HEIGHTS VARY BY LOCATION AND BOOTH CONFIGURATION. SEE SHOT SHOW DISPLAY REGULATIONS.
- NEITHER HANGING SIGNS NOR MULTI-LEVEL BOOTHS ARE PERMITTED IN G HALL OR THE LOWER LEVEL LOBBY DUE TO THE HEIGHT LIMITATIONS.

	EXPANSION JOINT
	ROLL-UP DOORS
	AIRWALLS
	LOW CEILINGS
	KEEP CLEAR
	OPEN ABOVE

FIRE AND SAFETY LEGEND

	<ul style="list-style-type: none"> - REQUIRED CLEAR SPACE FOR EGRESS PER C.C.F.D. - MUST REMAIN CLEAR OF OBSTRUCTIONS TO EGRESS. - ENTRANCE UNITS ARE ALLOWED, BUT MUST NOT OBSTRUCT EGRESS.
FHC	<ul style="list-style-type: none"> - FIRE HOSE CONNECTION - FIRE HOSE CONNECTION LOCATIONS VARY. REFER TO FLOOR PLAN/ ELEVATIONS FOR FHC LOCATIONS.
FE	<ul style="list-style-type: none"> - FIRE EXTINGUISHER CABINET - FE CABINETS VARY ON COLUMNS. REFER TO FLOOR PLAN/ ELEVATIONS FOR FE LOCATIONS.
FS	<ul style="list-style-type: none"> - FIRE ALARM STROBE - FS VARY IN HEIGHT FROM FLOOR.
FV	<ul style="list-style-type: none"> - FIRE HOSE VALVE - FIRE HOSE VALVE PIPE COMES FROM THE CEILING.
S	WALL SCONCE

- MUST MAINTAIN AT LEAST 36" OF ACCESS AROUND ALL FIRE EQUIPMENT.
- IT IS THE RESPONSIBILITY OF THE EXHIBITOR TO PROVIDE ACCESS TO FIRE EQUIPMENT WITHIN THEIR BOOTH.
- FIRE EXTINGUISHERS MAY BE BLOCKED ONLY WHEN A TEMPORARY FE IS PROVIDED.

Utility Notation: Hall G

EP	Electrical Panel
<ul style="list-style-type: none"> • PANEL BOX DIMENSIONS ARE 1'-9"W X 5'H, 16" FROM FLOOR TO BOTTOM OF PANEL BOX. • MANDATORY 3" "KEEP CLEAR" DESIGNATION (SEE PLAN). • 208V/60AMP, THREE PHASE (5 WIRE) AND, 208V/100AMP, THREE PHASE (5 WIRE). 	
E	Electrical Outlets
<ul style="list-style-type: none"> • ELECTRICAL OUTLETS HEIGHTS VARY. SEE ELEVATIONS FOR LOCATION • 208V/60AMP, THREE PHASE (5 WIRE). 	
T	Telephone Service Box
<ul style="list-style-type: none"> • TELEPHONE BOX DIMENSION ARE 1'W X 1'6"H, 3'-6" FROM FLOOR TO BOTTOM OF BOX. 	

COLUMN LEGEND

	COLUMN: APPROXIMATELY 2" DIAMETER
	COLUMN: APPROXIMATELY 2'-6" DIAMETER
	COLUMN: APPROXIMATELY 2'-6" x 3'-4"
	COLUMN: APPROXIMATELY 3'-6" x 3'-6"

ALL COLUMN SIZES AND LOCATIONS MAY VARY. REFER TO FLOOR PLAN FOR EXACT SIZE AND LOCATION.

COLUMN NOTATIONS

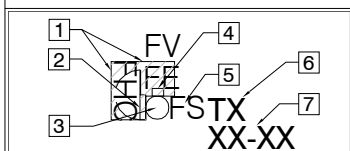

KEY

1	36" CLEARANCE AROUND FIRE EQUIPMENT (KEEP CLEAR)
2	28" x 38" x 6" FIRE CABINET
3	CONCRETE COLUMN
4	18" x 8" x 6" FIRE EXTINGUISHER AND/OR FIRE VALVE
5	FIRE STROBE
6	COLUMN TYPE
7	COLUMN NUMBER

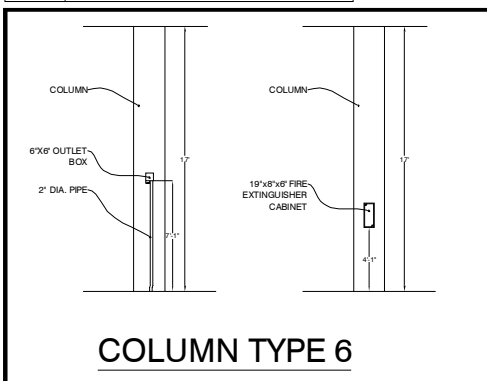

DISCLAIMER

EVERY EFFORT HAS BEEN MADE TO ENSURE THE ACCURACY OF ALL INFORMATION CONTAINED ON THIS FLOORPLAN. HOWEVER NO WARRANTIES, EITHER EXPRESSED OR IMPLIED ARE MADE WITH RESPECT TO THIS FLOORPLAN. IF THE LOCATION OF BUILDING COLUMNS, UTILITIES OR OTHER ARCHITECTURAL COMPONENTS OF THE FACILITY IS A CONSIDERATION IN THE CONSTRUCTION OR USAGE OF AN EXHIBIT, IT IS THE SOLE RESPONSIBILITY OF THE EXHIBITOR TO PHYSICALLY INSPECT THE FACILITY TO VERIFY ALL DIMENSIONS AND LOCATIONS.

© COPYRIGHT 2007, FREEMAN CO. ALL RIGHTS RESERVED.